

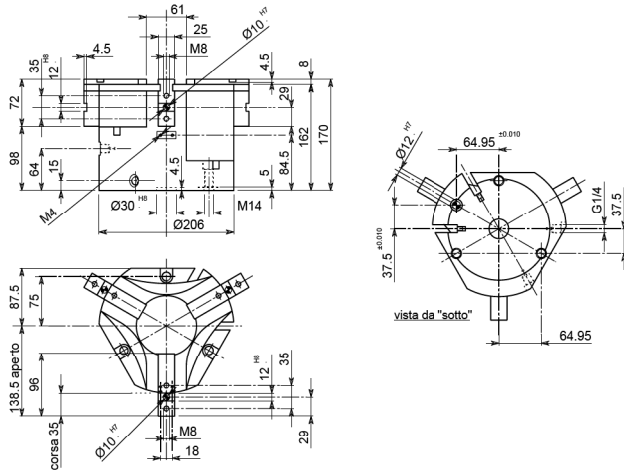

- **ORGANO DI PRESA A CORSA PARALLELA A TRE GRIFFE**
- **Three-jaw parallel gripper**
- **Drei-finger Parallelgreifer**
- **Pince de préhension à course parallèle, à trois griffes**

• Disegno OPE 205-3 • Drawing OPE 205-3 • Zeichnung OPE 205-3 • Dessin OPE 205-3



• Versione OPE 205-3 S • Version OPE 205-3 S • Ausführung OPE 205-3 S • Version OPE 205-3 S

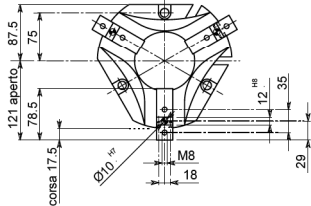

• Le dimensioni sono indicative e suscettibili di variazioni per migliori tecniche. Ci riserviamo di apportare modifiche senza preavviso • All dimensions are indicative and subject to variation for technical upgrading. We reserve the right to make alterations without prior notification • Die Maßangaben sind indikativ und können sich bei technischen Verbesserungen ändern. Wir behalten uns vor, ohne vorherige Benachrichtigung Änderungen vorzunehmen • Les dimensions sont fournies à titre indicatif; elles peuvent subir des variations pour cause d'améliorations techniques. Nous nous réservons le droit d'apporter des modifications sans préavis.

• SCHEMA DI FUNZIONAMENTO • OPERATIONAL DIAGRAM
• BETRIEBSSCHEMA • SCHEMA DE FONCTIONNEMENT

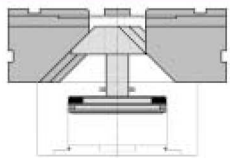

Aperto
Open
Geöffnet
Ouvert

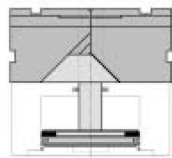

Chiuso
Closed
Geschlossen
Formé



tecnomors spa. - Via Roma 141/143 - 28017 San Maurizio d'Opaglio (NO) - Italy
tel.: 0322 96142 - fax.: 0322 967453 - e mail: info@tecnomors.it



- **ORGANO DI PRESA A CORSA PARALLELA A TRE GRIFFE**
- **Three-jaw parallel gripper**
- **Drei-finger Parallelgreifer**
- **Pince de préhension à course parallèle, à trois griffes**

DIAGRAMMA FORZA DI CHIUSURA
CLAMPING FORCE DIAGRAM • DIAGRAM SCHLIEßKRAFT
DIAGRAMME DE LA FORCE DE FERMETURE

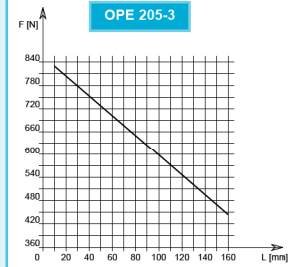

F = Forza di chiusura reale per griffa
L = Distanza di rilevamento
F = True clamping force per jaw
L = Reading distance

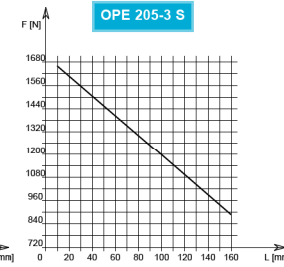

F = Reelle Schließkraft pro Greiffinger
L = Messungsabstand
F = Force de fermeture réelle par griffe
L = Distance de lecture

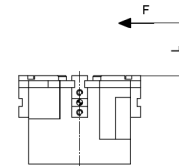

P = 6 bar

Valori nei dati tecnici rilevati alla distanza L = 20 mm • Technical specification values read at a distance L = 20 mm
• Werte der technischen Daten auf Distanz aufgenommen L = 20 mm • Valeurs des données techniques relevées à la distance L = 20 mm

DATI TECNICI

	OPE205-3	OPE205-3S
Corsa per griffa	35 mm	17.5 mm
Corsa pistone	35 mm	35 mm
Volume aria per doppia corsa	533 cm ³	533 cm ³
Forza teorica di chiusura per griffa a 6 bar	1470 N	2885 N
Forza reale di chiusura per griffa a 6 bar	805 N	1580 N
Forza teorica di apertura per griffa a 6 bar	1568 N	3078 N
Forza reale di apertura per griffa a 6 bar	859 N	1686 N
Pressione di esercizio	2-12 bar	2-12 bar
Ripetibilità	±0.05 mm	±0.05 mm
Peso	12 Kg	11.5 Kg
Temperatura di esercizio	-5-60 °C	-5-60 °C
Codice articolo	OE877PHE	OE677PHS

TECHNISCHE DATEN

	OPE205-3	OPE205-3S
Hub pro Greiffinger	35 mm	17.5 mm
Kolbenhub	35 mm	35 mm
Luftvolumen pro Doppelhub	533 cm ³	533 cm ³
Theoretische Schließkraft pro Greiffinger 6 bar	1470 N	2885 N
Reelle Schließkraft pro Greiffinger 6 bar	805 N	1580 N
Theoretische Öffnungskraft pro Greiffinger 6 bar	1568 N	3078 N
Reelle Öffnungskraft pro Greiffinger 6 bar	859 N	1686 N
Betriebsdruck	2-12 bar	2-12 bar
Wiederholbarkeit	±0.05 mm	±0.05 mm
Gewicht	12 Kg	11.5 Kg
Betriebstemperatur	-5-60 °C	-5-60 °C
Artikelcode	OE877PHE	OE677PHS

SPECIFICATIONS

	OPE205-3	OPE205-3S
Stroke per jaw	35 mm	17.5 mm
Piston stroke	35 mm	35 mm
Dual stroke air volume	533 cm ³	533 cm ³
Theoretical clamping force per jaw at 6 bar	1470 N	2885 N
Actual clamping force per jaw at 6 bar	805 N	1580 N
Theoretical opening force per jaw at 6 bar	1568 N	3078 N
Actual opening force per jaw at 6 bar	859 N	1686 N
Working pressure	2-12 bar	2-12 bar
Reproducibility	±0.05 mm	±0.05 mm
Weight	12 Kg	11.5 Kg
Working temperature	-5-60 °C	-5-60 °C
Article code	OE877PHE	OE677PHS

DONNÉES TECHNIQUES

	OPE205-3	OPE205-3S
Course par griffe	35 mm	17.5 mm
Course piston	35 mm	35 mm
Volume d'air pour course double	533 cm ³	533 cm ³
Force théorique en fermeture par griffe à 6 bar	1470 N	2885 N
Force réelle en fermeture par griffe à 6 bar	805 N	1580 N
Force théorique en ouverture par griffe à 6 bar	1568 N	3078 N
Force réelle en ouverture par griffe à 6 bar	859 N	1686 N
Pression d'exercice	2-12 bar	2-12 bar
Répétibilité	±0.05 mm	±0.05 mm
Poids	12 Kg	11.5 Kg
Température d'exercice	-5-60 °C	-5-60 °C
Code article	OE877PHE	OE677PHS



tecnomors spa. - Via Roma 141/143 - 28017 San Maurizio d'Opaglio (NO) - Italy
tel.: 0322 96142 - fax.: 0322 967453 - e mail: info@tecnomors.it

OPE 205-3
OPE 205-3 S

OPE 175-3
OPE 175-3 S

OPE 125-3
OPE 125-3 S

OPE 110-3
OPE 110-3 S

OPE 105-3
OPE 105-3 S

OPE 90-3
OPE 90-3 S

OPE 80-3
OPE 80-3 S

OPE 65-3
OPE 65-3 S

OPE 60-3
OPE 60-3 S

OPE 205-3
OPE 205-3 S

OPE 175-3
OPE 175-3 S

OPE 125-3
OPE 125-3 S

OPE 110-3
OPE 110-3 S

OPE 105-3
OPE 105-3 S

OPE 90-3
OPE 90-3 S

OPE 80-3
OPE 80-3 S

OPE 65-3
OPE 65-3 S

OPE 60-3
OPE 60-3 S