

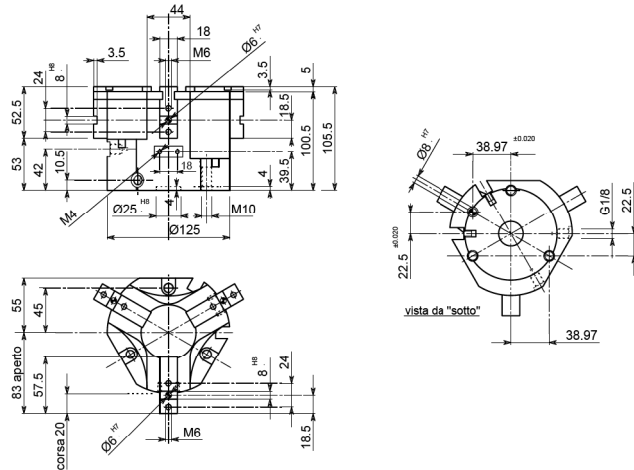

- **ORGANO DI PRESA A CORSA PARALLELA A TRE GRIFFE**
- **Three-jaw parallel gripper**
- **Drei-finger Parallelgreifer**
- **Pince de préhension à course parallèle, à trois griffes**

• Disegno OPE 125-3 • Drawing OPE 125-3 • Zeichnung OPE 125-3 • Dessin OPE 125-3



• Versione OPE 125-3 S • Version OPE 125-3 S • Ausführung OPE 125-3 S • Version OPE 125-3 S

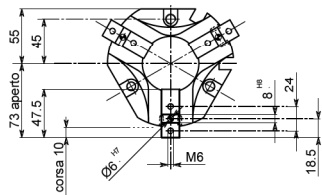

• Le dimensioni sono indicative e suscettibili di variazioni per migliorie tecniche. Ci riserviamo di apportare modifiche senza preavviso • All dimensions are indicative and subject to variation for technical upgrading. We reserve the right to make alterations without prior notification • Die Maßangaben sind inkativ und können sich bei technischen Verbesserungen ändern. Wir behalten uns vor, ohne vorherige Benachrichtigung Änderungen vorzunehmen • Les dimensions sont fournies à titre indicatif; elles peuvent subir des variations pour cause d'améliorations techniques. Nous nous réservons le droit d'apporter des modifications sans préavis.

• SCHEMA DI FUNZIONAMENTO • OPERATIONAL DIAGRAM  
• BETRIEBSSCHEMA • SCHEMA DE FONCTIONNEMENT

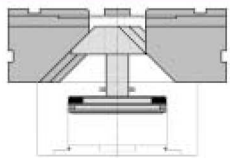

Aperto  
Open  
Geöffnet  
Ouvert

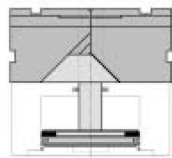

Chiuso  
Closed  
Geschlossen  
Formé



tecnomors spa. - Via Roma 141/143 - 28017 San Maurizio d'Opaglio (NO) - Italy  
tel.: 0322 96142 - fax.: 0322 967453 - e mail: info@tecnomors.it



- **ORGANO DI PRESA A CORSA PARALLELA A TRE GRIFFE**
- **Three-jaw parallel gripper**
- **Drei-finger Parallelgreifer**
- **Pince de préhension à course parallèle, à trois griffes**

DIAGRAMMA FORZA DI CHIUSURA  
CLAMPING FORCE DIAGRAM • DIAGRAM SCHLIEßKRAFT  
DIAGRAMME DE LA FORCE DE FERMETURE

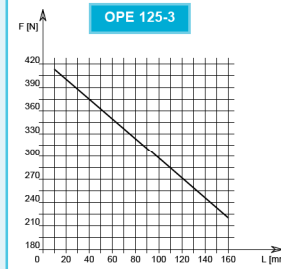

F = Forza di chiusura reale per griffa  
L = Distanza di rilevamento  
F = True clamping force per jaw  
L = Reading distance

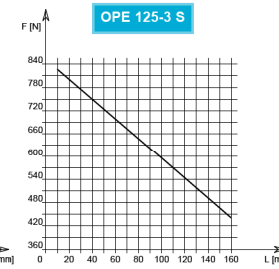

F = Reelle Schließkraft pro Greiffinger  
L = Messungsabstand  
F = Force de fermeture réelle par griffe  
L = Distance de lecture

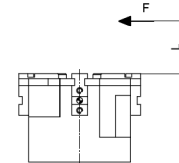

P = 6 bar

Valori nei dati tecnici rilevati alla distanza L = 20 mm • Technical specification values read at a distance L = 20 mm  
• Werte der technischen Daten auf Distanz aufgenommen L = 20 mm • Valeurs des données techniques relevées à la distance L = 20 mm

DATI TECNICI

	OPE125-3	OPE125-3S
Corsa per griffa	20 mm	3 mm
Corsa pistone	20 mm	20 mm
Volume aria per doppia corsa	150 cm <sup>3</sup>	150 cm <sup>3</sup>
Forza teorica di chiusura per griffa a 6 bar	729 N	1431 N
Forza reale di chiusura per griffa a 6 bar	400 N	787 N
Forza teorica di apertura per griffa a 6 bar	769 N	1434 N
Forza reale di apertura per griffa a 6 bar	422 N	830 N
Pressione di esercizio	2-12 bar	2-12 bar
Ripetibilità	±0.05 mm	±0.05 mm
Peso	3.15 Kg	2.95 Kg
Temperatura di esercizio	-5-60 °C	-5-60 °C
Codice articolo	.OE875PFE	.OE675PFS

TECHNISCHE DATEN

	OPE125-3	OPE125-3S
Hub pro Greiffinger	20 mm	3 mm
Kolbenhub	20 mm	20 mm
Luftvolumen pro Doppelhub	150 cm <sup>3</sup>	150 cm <sup>3</sup>
Theoretische Schließkraft pro Greiffinger 6 bar	729 N	1431 N
Reelle Schließkraft pro Greiffinger 6 bar	400 N	787 N
Theoretische Öffnungskraft pro Greiffinger 6 bar	769 N	1434 N
Reelle Öffnungskraft pro Greiffinger 6 bar	422 N	830 N
Betriebsdruck	2-12 bar	2-12 bar
Wiederholbarkeit	±0.05 mm	±0.05 mm
Gewicht	3.15 Kg	2.95 Kg
Betriebstemperatur	-5-60 °C	-5-60 °C
Artikelcode	.OE875PFE	.OE675PFS

SPECIFICATIONS

	OPE125-3	OPE125-3S
Stroke per jaw	20 mm	3 mm
Piston stroke	20 mm	20 mm
Dual stroke air volume	150 cm <sup>3</sup>	150 cm <sup>3</sup>
Theoretical clamping force per jaw at 6 bar	729 N	1431 N
Actual clamping force per jaw at 6 bar	400 N	787 N
Theoretical opening force per jaw at 6 bar	769 N	1434 N
Actual opening force per jaw at 6 bar	422 N	830 N
Working pressure	2-12 bar	2-12 bar
Reproducibility	±0.05 mm	±0.05 mm
Weight	3.15 Kg	2.95 Kg
Working temperature	-5-60 °C	-5-60 °C
Article code	.OE875PFE	.OE675PFS

DONNÉES TECHNIQUES

	OPE125-3	OPE125-3S
Course par griffe	20 mm	3 mm
Course piston	20 mm	20 mm
Volume d'air pour course double	150 cm <sup>3</sup>	150 cm <sup>3</sup>
Force théorique en fermeture par griffe à 6 bar	729 N	1431 N
Force réelle en fermeture par griffe à 6 bar	400 N	787 N
Force théorique en ouverture par griffe à 6 bar	769 N	1434 N
Force réelle en ouverture par griffe à 6 bar	422 N	830 N
Pression d'exercice	2-12 bar	2-12 bar
Répétibilité	±0.05 mm	±0.05 mm
Poids	3.15 Kg	2.95 Kg
Température d'exercice	-5-60 °C	-5-60 °C
Code article	.OE875PFE	.OE675PFS



tecnomors spa. - Via Roma 141/143 - 28017 San Maurizio d'Opaglio (NO) - Italy  
tel.: 0322 96142 - fax.: 0322 967453 - e mail: info@tecnomors.it

OPE 205-3  
OPE 205-3 S

OPE 175-3  
OPE 175-3 S

OPE 125-3  
OPE 125-3 S

OPE 110-3  
OPE 110-3 S

OPE 105-3  
OPE 105-3 S

OPE 90-3  
OPE 90-3 S

OPE 80-3  
OPE 80-3 S

OPE 65-3  
OPE 65-3 S

OPE 60-3  
OPE 60-3 S

OPE 205-3  
OPE 205-3 S

OPE 175-3  
OPE 175-3 S

OPE 125-3  
OPE 125-3 S

OPE 110-3  
OPE 110-3 S

OPE 105-3  
OPE 105-3 S

OPE 90-3  
OPE 90-3 S

OPE 80-3  
OPE 80-3 S

OPE 65-3  
OPE 65-3 S

OPE 60-3  
OPE 60-3 S